

railprofiel A001

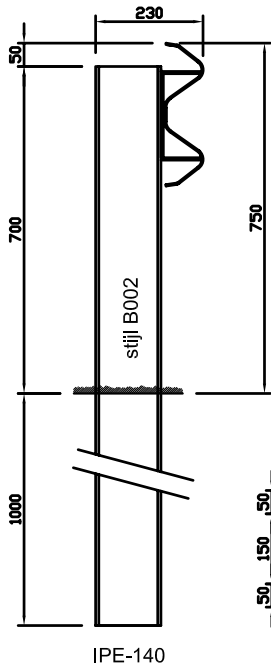

railprofiel B001

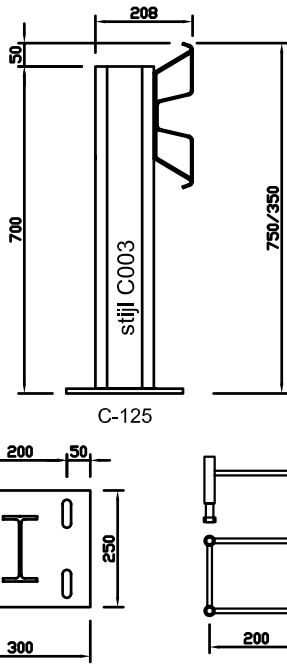

koker LS150/180

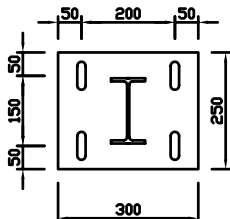
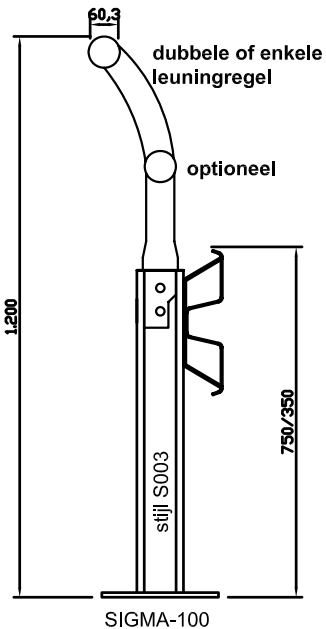
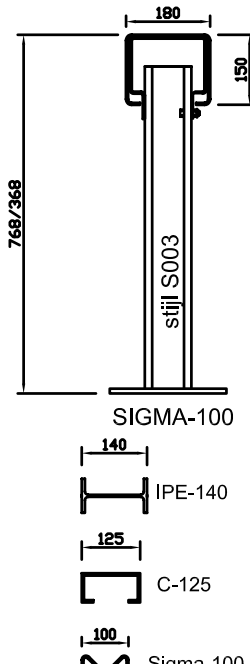

Voetplaat 10 mm. dik

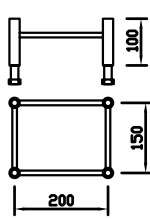

instort-anker

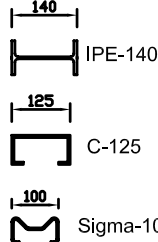

VS-01

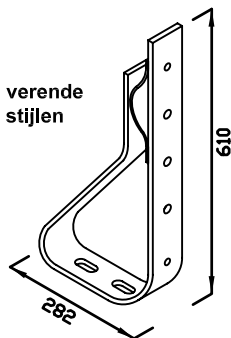

VS-02

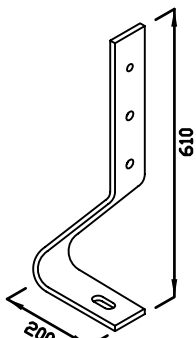

VS-03

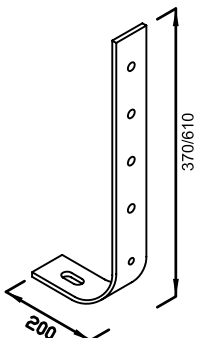

VS-05

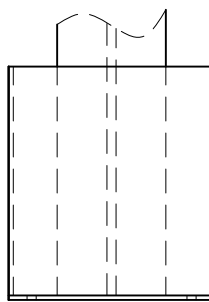
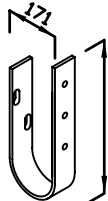

variabel

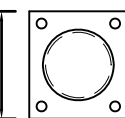
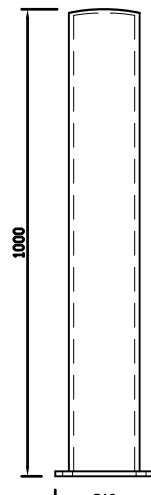

afscherm paal

elndstuk A/B 014

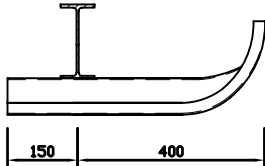

kopstuk A/B 007

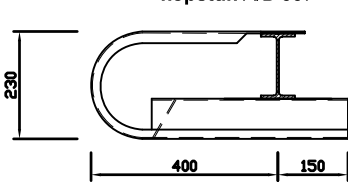

kolombeschermer

omkeerstuk A/B 008

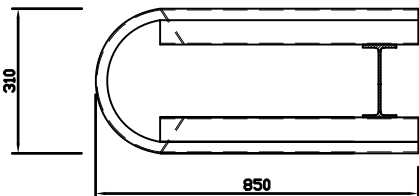

knikplank A/B 016

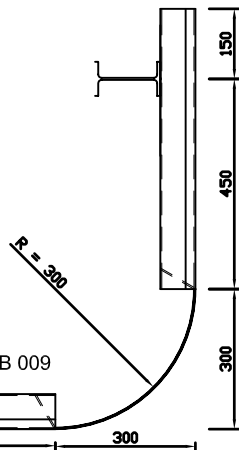
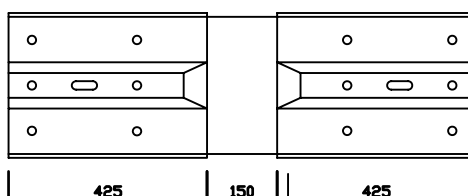

bochtstuk A/B 009

buitenhoekstuk A/B 012

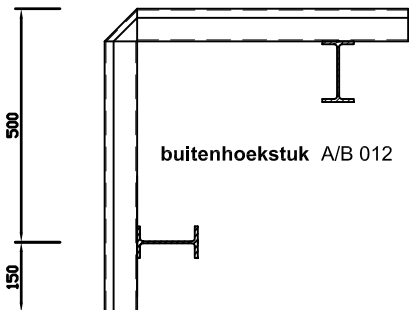

binnenhoekstuk A/B 010

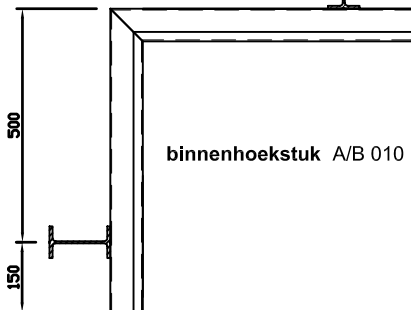

eurorail®

geleiderailconstructies - aanrijdbeveiligingen - geluidsschermen
heilhamers - plaatstalen duikers - wegmeubilair - markeringen

postbus 62 - 8060 AB HASSELT - tel. 038-4773340 - info@eurorail.nl